

fontargen brazing  
by voestalpine

Let's Braze  
Together!

Brazing basics, materials,  
solders, fluxes

voestalpine Böhler Welding  
[www.voestalpine.com/welding](http://www.voestalpine.com/welding)



# Brazing what and how – a concise overview for you!

## Contents

1. Basics and terms
2. The right application
3. What do I braze with what?
4. Who we are

### Twice as helpful.

This booklet has two purposes. First, it offers brazing newcomers insight into the world of brazing and its terms. Second, it is a small, compact reference guide for brazing experts, letting them quickly see which brazing solders and fluxes are best to use with which metallic materials.

### Brazing experts around the world see red –

and they've been turning to that colour for more than 50 years. A fact that pleases us since red is the colour of our product brand Fontargen Brazing. At the end of this booklet, we give you a brief introduction to us and our company voestalpine Böhler Welding.

We wish you much success with this brazing booklet.

Mr. Braze

Owner and publisher:  
voestalpine Böhler Welding GmbH,  
Kerpelystraße 199, 8700 Leoben, Austria

Project management:  
Jutta Hackstock-Sabitzer,  
VP Global Communication & CRM

Text and graphics: Reichl und Partner Werbeagentur GmbH

Photos: voestalpine Böhler Welding, unless indicated  
otherwise

A stylized illustration of a welder with a beard and safety glasses, wearing a grey jacket over a red shirt. He is holding a welding torch in his right hand and an open book in his left. The background is a textured, grey, cracked wall. A red brushstroke graphic is positioned behind the chapter title.

Chapter 1

# Basics and terms

## Why brazing?

Using brazing to join metallic materials has certain advantages:

- » The joint strength can match or exceed the strength of the base material
- » Brazing is production-efficient and cost-effective
- » The working temperature is lower than when welding, minimizing component deformation
- » Different base materials can be joined
- » Thin and thick-walled components can be joined
- » Small and wide gaps can be filled

# Brazing is precise

Also when it comes to terms and definitions



**Brazing** is a process in which two or more items (usually metal) are joined together by melting and putting a filler metal (solder) into the joint, the filler metal having a lower melting point than the adjoining metal. Brazing differs from welding in that the solidus temperature of the base material is not reached. Brazing, or hard soldering, is when the working temperature of the solder is above 450 °C. Soldering, or soft soldering, is when the temperature is below 450 °C.



**Solders** join the base materials and consist of alloys that melt easily (e.g. silver, copper, zinc, tin / L-Ag55Sn) or pure metal (e.g. copper). Melting range: from when melting starts (solidus temperature  $T_s$ ) until the solder is completely liquid (liquidus temperature  $T_L$ ). Working temperature  $T_A$ : lowest surface temperature needed for the solder to wet the base material joining surfaces.



**Brazing fluxes** in accordance to DIN EN 1045 (DIN 8511) are nonmetallic materials, e.g. silicates, carbonates, borates, chlorides, and fluorides. Their task is to:

- » prevent additional formation of oxide on the component surface during heating;
- » reduce the oxide before the solder melts;
- » eliminate oxide during soldering and preventing it from reforming;
- » minimize the surface tension of the melted solder to improve the flow over the base material (known as wetting).

## Fluxes for brazing heavy metals:

These are known as type FH. They mainly consist of boron compounds and fluorides. The groups of numbers from 10 to 40 regulate the working temperature range and the corrosiveness. Examples:

### Type FH10

Working range 550°C to 800 °C; application: silver-based brazing solders. The residues are corrosive and must be removed.

### Type FH21

Working range 750 °C to 1100 °C; application: brass and German silver brazing alloys solders. The residues are not corrosive and can remain on the component.

## Fluxes for brazing light metals:

The type FL class encompasses two types of fluxes that work above 550 °C and are used to braze aluminum.

### Type FL10

Contains hygroscopic chloride. The residues are corrosive and must be removed.

### Type FL20

Does not contain hygroscopic chloride. The residues are not corrosive and can remain on the component.

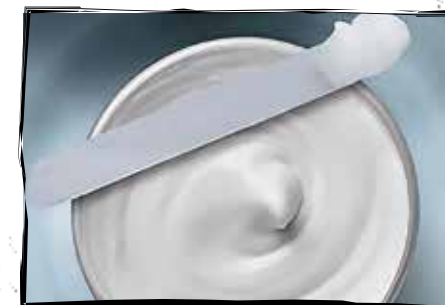



Chapter 2

# The right application

When brazing metallic materials, many factors are important: the right solder, the right flux, the right application – and perfectly matching all influencing factors. Because as we brazing experts know, only one thing counts: the result. My tips and insight into the brazing steps on the next pages will help you achieve the perfect result.

# Be particular!

### The right solder

The solder alloy must be chosen based on its suitability for the brazing task. The parameters are: the shape of the workpiece that is to be brazed, the base material, the application in which the workpiece will be used (e.g. the solder's resistance to corrosion, the maximum operating temperature), and naturally the required strength of the brazing joint as well as the media that will come into contact with the brazing joint.

### The right flux

Choosing the right flux mainly depends on the choice of solder alloy, which in turn depends on the base materials that are to be joined. The melting range of the flux must be within the working temperature range of the solder.

### Copper-phosphorus brazing solders

Application: gap soldering on copper, brass, bronze, red brass. Effect: The phosphorus embedded in the solder acts deoxidizing and has a flux effect. Therefore, these solders can be used on copper-to-copper joints without flux. With restrictions, flux-free soldering is also possible on a few alloys such as copper-zinc. This solder should not be used without flux on copper alloys such as brass, etc. A flux from the FH10 group can be used, for example F 300 H Ultra NT.

Even without flux



# Attention!

Never use copper-phosphorus brazing solders to braze iron or nickel-based alloys.

This will cause the formation of iron or nickel phosphide, which will make the brazing seam brittle. This solder alloy is also not suitable for brazing joints that will be used in sulfuric atmospheres.



# How to achieve a clean result



**Cleaning the component before soldering**  
The workpieces/components that are to be joined should have a clean, oil-, grease-, and oxide-free surface. Degreasing solvents are the best way to remove lubricants and oils. Use a cleaning fleece or sandpaper to remove the oxide from surfaces.

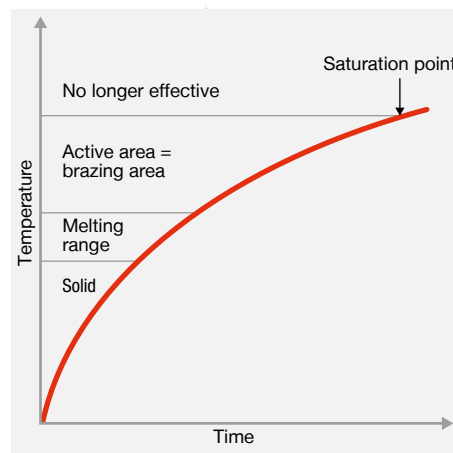

Behavior of the flux during brazing

## Applying the flux

Today, flux is primarily in the form of a paste though flux powder still has its applications. The graph shows the behavior of the flux in the brazing process over time and temperature.

As the temperature increases, the water in the flux paste evaporates. The flux „swells” and then dries as a white residue on the component. Just before the brazing temperature is reached, the flux liquefies again. It becomes clear and transparent. At the beginning of its working temperature, the flux becomes active and oxides are reduced. This is the range in which the working temperature of the brazing solder has to be reached. After one or two minutes, the flux is saturated with oxides and is no longer effective. Increasing the temperature above the working temperature range also makes the flux ineffective.

← Flux operating principle

If the solder has not flowed by this point in time, it could be due to the following reasons:

- » Incorrect application of heat, especially in parts with widely varying material thicknesses;
- » Using a heat source with a too low power density (e.g. propane instead of acetylene gas).

← Visual check

# The right temperatures make the difference



According to heat source:

Flame brazing  
With fuel gas or air-gas torch

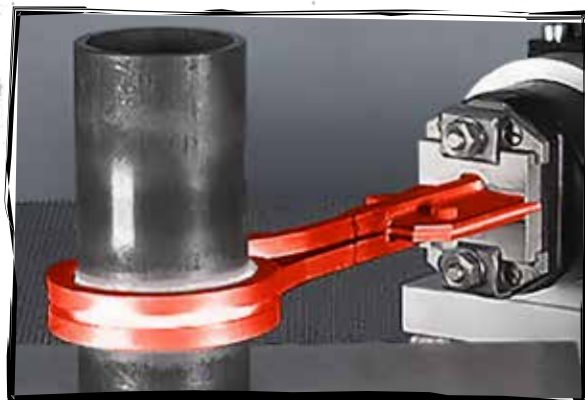

Induction brazing  
Using electromagnetic fields to produce heat

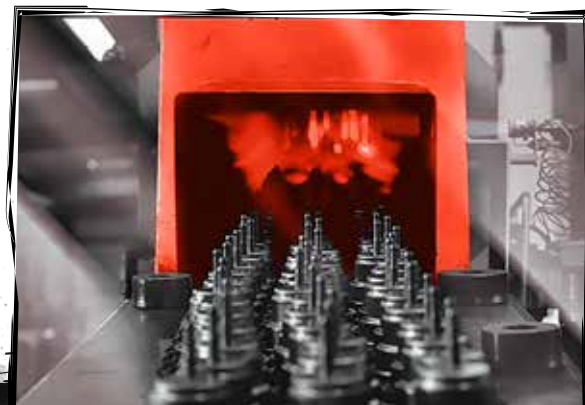

Furnace brazing  
Different processes; here continuous furnace

Many brazing processes take place in a vacuum furnace.

## Heating parts and applying the solder

There are different heat sources for soldering with brazing solders. When brazing, it is important that the base materials be uniformly/evenly and quickly heated to the required brazing temperature.

Note that when joining parts have different sizes, densities, and/or poorer thermal conductivity, they will have to be heated up comparatively longer and at a higher temperature. When the brazing temperature has been reached, the solder should be positioned at the solder gap so that it will be pulled into the gap through capillary action, and, if there is a sufficient amount of solder, can form a concave fillet. When using a viscous solder alloy such as nickel silver and brass solders, the solder should be applied along the entire brazing joint in order to form a continuous brazed seam.

Note that similar to fluxes, the melted solder always flows at the hottest point of the brazing joint. Heat should be applied during the entire brazing process and ideally slightly longer to achieve a continual diffusion zone.

### Removing flux residues

Corrosive fluxes (e.g. classes FH 10, FH 20, and FH 40) must be removed. The following procedures have proven effective in practice:

- » Mechanical (sanding, milling, blasting)
- » Brushing in hot water
- » Pickling in a bath temperature of around 40 °C
- » Quenching the parts while they are still hot (in this case, make sure that the base material and solder are not damaged due to structural changes, brittleness, tension, etc.)

Non-corrosive fluxes (e.g. classes FH 21, FL 20) can remain on the part.





# What do I braze with what?

This table tells brazing experts everything at a glance. Base materials, solders, fluxes – here you can see what works best with what. The following pages provide detailed information on solders and fluxes.



Selection table: Base materials/solders

Base materials	Stainless steel	Nickel and nickel alloys	Steel	Zinc-coated steel	Cast iron	Copper	Copper alloys	Aluminum
Stainless steel	AF 314 AF 319 AF 320 AF 347 AF 350 AF 390	AF 314 AF 319 AF 320 AF 347 AF 350 AF 390	AF 314 AF 319 AF 320 AF 347 AF 350 AF 390	AF 314 AF 319 AF 320 AF 347 AF 350 AF 390	AF 314 AF 319 AF 320 AF 347 AF 350 AF 390	AF 314 AF 319 AF 320 AF 347 AF 350 AF 390	AF 314 AF 319 AF 320 AF 347 AF 350 AF 390	A 407 L + F 400 MD
Nickel and nickel alloys		AF 314 AF 319 AF 320 AF 347 AF 350 AF 390	AF 314 AF 319 AF 320 AF 347 AF 350 AF 390	AF 314 AF 319 AF 320 AF 347 AF 350 AF 390	AF 314 AF 319 AF 320 AF 347 AF 350 AF 390	AF 314 AF 319 AF 320 AF 347 AF 350 AF 390	AF 314 AF 319 AF 320 AF 347 AF 350 AF 390	
Steel			AF 314 AF 319 AF 320 AF 347 AF 350 AF 390 A /AF 210 A 202 M	AF 314 AF 319 AF 320 AF 347 AF 350 AF 390 A /AF 210 A 202 M	AF 314 AF 319 AF 320 AF 347 AF 350 AF 390 A /AF 210	AF 314 AF 319 AF 320 AF 347 AF 350 AF 390 A /AF 210 A 202 M	AF 314 AF 319 AF 320 AF 347 AF 350 AF 390 A /AF 210 A 202 M	A 407 L + F 400 MD
Zinc-coated steel				AF 314 AF 319 AF 320 AF 347 AF 350 AF 390 A /AF 210	AF 314 AF 319 AF 320 AF 347 AF 350 AF 390 A /AF 210	AF 314 AF 319 AF 320 AF 347 AF 350 AF 390 A /AF 210	AF 314 AF 319 AF 320 AF 347 AF 350 AF 390 A /AF 210	
Cast iron					AF 314 AF 319 AF 320 AF 347 AF 350 AF 390 A /AF 210	AF 314 AF 319 AF 320 AF 347 AF 350 AF 390 A /AF 210	AF 314 AF 319 AF 320 AF 347 AF 350 AF 390 A /AF 210	
Copper						AF 314 AF 319 AF 320 AF 347 AF 350 AF 390 A 2004 V A 3002 V A 3005 V A /AF 210	AF 314 AF 319 AF 320 AF 347 AF 350 AF 390 A 2004 V A 3002 V A 3005 V only use with flux! "F 300 H Ultra NT" A /AF 210 A 202 M	A 407 L + F 400 MD
Copper alloys							AF 314 AF 319 AF 320 AF 347 AF 350 AF 390 A 2004 V A 3002 V A 3005 V only use with flux! "F 300 H Ultra NT" A /AF 210 A 202 M	A 407 L + F 400 MD
Aluminum								A 407 L + F 400 MD

Overview of Fontargen Brazing product groups:  
■ Copper wire (CuSi3-wire)  
■ Aluminium solder  
■ Brass solder  
■ Silver solder  
■ Copper-Phosphor (-Silver) solder

# Fontargen A 210

Brass hard solder



Classifications			
DIN EN ISO 17672	DIN EN 1044	DIN 8513	DIN EN ISO 3677
Cu 470a	CU 301	L-CuZn40	B-Cu60Zn(Si)-875/895
Material no.			
2.0367			

Composition, typical analysis (% w/w):						
Cu	Zn	Sn	Si	Mn	Fe	
60.00	Rest	< 0.20	0.30	< 0.15	< 0.25	

Technical specifications			
Working temperature	900 °C	Elongation	35%
Melting range	875 - 895 °C	Electrical conductivity	15 Sm/mm <sup>2</sup>
Specific weight	8.4 g/cm <sup>3</sup>	Hardness	110 HB
Tensile strength	350 N/mm <sup>2</sup>		

#### Characteristics/application

Brazing alloy with good flowing properties, fairly insensitive to overheating. For gap brazing, joint brazing, and coating of steel, malleable cast iron, as well as copper and copper alloys with a solidus of > 900 °C.

#### Heat sources

Acetylene torch, conduction and resistance heating

#### Flux

F 100 series  
Rapidflux series

All provided information is based on careful investigation and comprehensive research. Nevertheless, we do not assume any warranty and liability for the correctness of the information or changes.

# Fontargen A 314

Cadmium-free silver alloy



Classifications			
DIN EN ISO 17672	DIN EN 1044	DIN 8513	DIN EN ISO 3677
Ag 155Si	AG 103	L-Ag55Sn	B-Ag55ZnCuSn(Si)-630/660
Material no.			
2.5159			

Composition, typical analysis (% w/w):					
Ag	Cu	Zn	Sn		
55.00	21.00	22.00	2.00		

Technische Angaben			
Working temperature	650 °C	Elongation	25%
Melting range	630 - 660 °C	Electrical conductivity	7 Sm/mm <sup>2</sup>
Specific weight	9.4 g/cm <sup>3</sup>	Hardness	110 HB
Tensile strength	330 - 430 N/mm <sup>2</sup>		

#### Characteristics/application

Low melting point, cadmium-free silver brazing alloy that is insensitive to overheating. For gap brazing of alloyed and unalloyed steel, nickel and nickel alloys, malleable cast iron, copper and copper alloys, and carbides. Achieves the best color matching when brazing stainless steel. Suitable for parts that will be used in seawater in accordance with marine code VG 81245, section 3. The absence of cadmium makes it especially suitable for brazing joints destined to come in contact with food. For brazing joints with a working temperature of -200 °C on austenitic steels, -70 °C on ferritic steels, and up to +200 °C. The temperature stability of brazing connections also depends on the design (gap geometry) and the base materials that are to be brazed, and may need to be established in a process qualification test.

#### Heat sources

Acetylene torch, air-gas torch, induction and resistance heating

#### Flux

F 300 series

All provided information is based on careful investigation and comprehensive research. Nevertheless, we do not assume any warranty and liability for the correctness of the information or changes.

# Fontargen A 319

Cadmium-free silver alloy



Classifications			
DIN EN ISO 17672	DIN EN 1044	DIN 8513	DIN EN ISO 3677
Ag 134Si	AG 106	L-Ag34Sn	B-Cu36AgZnSn(Si)-630/730
Material no.			
2.5157			

#### Composition, typical analysis (% w/w):

Ag	Cu	Zn	Sn				
34.00	36.00	27.50	2.50				

#### Technical specifications

Working temperature	710 °C	Tensile strength	360 - 480 N/mm <sup>2</sup>
Melting range	630 - 730 °C	Elongation	12%
Specific weight	9 g/cm <sup>3</sup>	Electrical conductivity	14 Sm/mm <sup>2</sup>

#### Characteristics/application

Cadmium-free brazing alloy for gap brazing of alloyed and unalloyed steel, nickel and nickel alloys, malleable cast iron, copper and copper alloys. Suitable for copper pipe installation in accordance with DVGW work certificate GW 2. For brazing joints with a working temperature of -200 °C on austenitic steels, -70 °C on ferritic steels, and up to +200 °C. The temperature stability of solder connections also depends on the design (gap geometry) and the base materials that are to be brazed, and may need to be established in a process qualification test.

#### Heat sources

Acetylene torch, air-gas torch, induction and resistance heating

#### Flux

F 300 series

# Fontargen A 320

Cadmium-free silver alloy



Classifications			
DIN EN ISO 17672	DIN EN 1044	DIN 8513	DIN EN ISO 3677
Ag 145Si	AG 104	L-Ag45Sn	B-Ag45CuZnSn(Si)-640/680
AWS A 5.8		Material no.	
BAg-36		2.5158	

#### Composition, typical analysis (% w/w):

Ag	Cu	Zn	Sn				
45.00	27.00	25.50	2.50				

#### Technical specifications

Working temperature	670 °C	Tensile strength	350 - 430 N/mm <sup>2</sup>
Melting range	640 - 680 °C	Elongation	12%
Specific weight	9.2 g/cm <sup>3</sup>	Electrical conductivity	13 Sm/mm <sup>2</sup>

#### Characteristics/application

Cadmium-free brazing alloy for gap brazing of alloyed and unalloyed steel, nickel and nickel alloys, malleable cast iron, copper and copper alloys. Suitable for copper pipe installation in accordance with DVGW work certificate GW 2 and for parts that will be used in seawater in accordance with marine code VG 81245, section 3. For brazing joints with a working temperature of -200 °C on austenitic steels, -70 °C on ferritic steels, and up to +200 °C. The temperature stability of solder connections also depends on the design (gap geometry) and the base materials that are to be brazed, and may need to be established in a process qualification test.

#### Fluxes

Acetylene torch, air-gas torch, induction and resistance heating

#### Flussmittel

F 300 series

# Fontargen A 347

Silver brazing alloy, cadmium-free



Classifications			
DIN EN ISO 17672	DIN EN 1044	DIN 8513	DIN EN ISO 3677
Ag 156	AG 102	L-Ag56Sn	B-Ag56CuZnSn-620/655
AWS A 5.8	Material no.		
BAG-7			

#### Composition, typical analysis (% w/w):

Ag	Cu	Zn	Sn				
96.00	22.00	17.00	5.00				

#### Technical specifications

Working temperature	650 °C	Tensile strength	350 - 430 N/mm <sup>2</sup>
Melting range	620 - 655 °C	Elongation	12%
Specific weight	9.5 g/cm <sup>3</sup>	Electrical conductivity	7 Sm/mm <sup>2</sup>

#### Characteristics/application

Silver-bearing, cadmium-free low melting brazing alloy, insensitive to overheating for gap and joint brazing of alloyed and unalloyed steel, nickel, nickel alloys and malleable iron as well as the corresponding metals amongst each other. Brazing stainless steel provides the best possible colour match. The absence of cadmium makes it especially suitable for joints destined to come in contact with food. For applications with service temperatures until 200°C suitable.

#### Heat sources

Flame, induction and resistance heating

#### Flux

F 300 – Series

# Fontargen A 350

Silver brazing alloy, cadmium free



Classifications			
DIN EN ISO 17672	DIN EN 1044	DIN 8513	DIN EN ISO 3677
Ag 450			B-Ag50ZnCuNi-660/705
AWS A5.8	AMS	Material no.	
BAG-24	4788 B		

#### Composition, typical analysis (% w/w):

Ag	Cu	Zn	Ni				
50.00	20.00	28.00	2.00				

#### Technische Angaben

Working temperature	690 °C		
Melting range	660 - 705 °C		
Specific weight	9.2 g/cm <sup>3</sup>		

#### Characteristics/application

Nickel bearing silver brazing alloy with very good wetting properties on steel and hard metals, therefore ensuring very tough joints. Gap brazing of hard metals in combination with steel, tungsten, tantalum and molybdenum materials.

#### Heat sources

Flame, induction and resistance heating

#### Brazing fluxes

F 300 – Series

## Fontargen A 390

Silver brazing alloy, cadmium-free



### Classifications

DIN EN ISO 17672	DIN EN 1044	DIN 8513	DIN EN ISO 3677
Ag 245			B-Ag45CuZn-665/745
AWS A 5.8	Material no.		
B-Ag-5			

### Composition, typical analysis (% w/w):

Ag	Cu	Zn				
45.00	30.00	25.00				

### Technical specifications

Working temperature	740 °C	Elongation	25%
Melting range	665 - 745 °C		
Specific weight	8.9 g/cm <sup>3</sup>		

### Characteristics/application

Cadmium free brazing alloy with good fluidity and capillary flow characteristics. For gap brazing of steel, malleable cast iron, copper and copper alloys, Nickel and nickel alloys, food industry, breweries, Dairies, apparatus engineering, precision mechanics, musical instruments, Precision tooling, refrigeration, aircraft construction, shipbuilding. Suitable for soldering when used in sea water.

### Heat sources

Flame, induction and resistance heating

### Flux

F 300 - Series

## Fontargen A 2003 FreeFlow

Copper-phosphorus alloy

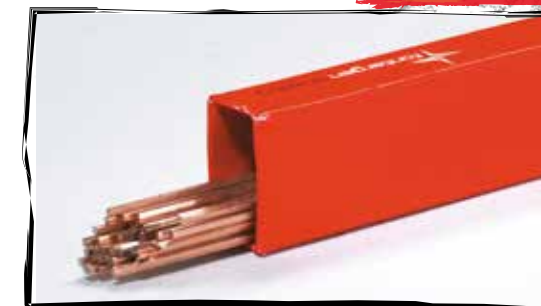

### Classifications

DIN EN ISO 17672	DIN EN 1044	DIN 8513	DIN EN ISO 3677
CuP 180	CP 202	L-Cu P 7	B-Cu93P-710/793
AWS A5.8	Material no.		
BCuP-2	2.1463		

### Composition, typical analysis (% w/w):

Cu	P					
Remainder	7.25					

### Technical specifications

Working temperature	730 °C	Tensile strength	250 N/mm <sup>2</sup>
Melting range	710 - 793 °C	Elongation	5%
Specific weight	8.1 g/cm <sup>3</sup>		

### Characteristics/application

A 2003 FreeFlow is a very homogeneous and capillary active brazing alloy. Its high flow characteristics allows the operator to produce fast reproducible joint assemblies for gap brazing on copper, brass, tin bronze and gunmetal. It suits to brazing joints operated at temperatures between -60 °C and +150 °C (determined by notched flexural impact tests acc. To DIN EN 10045). Do not use in sulphurous environment and on Fe- and Ni- containing base alloys.

### Heat sources

Flame, induction and resistance heating, TIG-torch.

### Brazing fluxes

Only copper alloys require the use of flux  
F 300 - Series

## Fontargen A 2004

Copper-phosphorus alloy

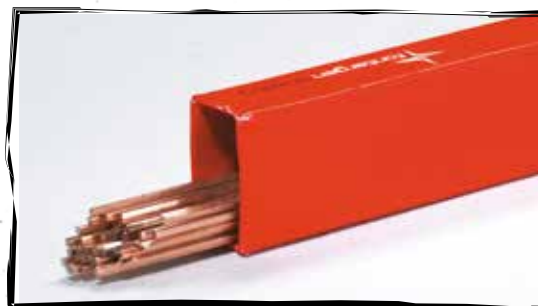

### Classifications

DIN EN ISO 17672	DIN EN 1044	DIN 8513	DIN EN ISO 3677
CuP 179	CP 203	L-CuP6	B-Cu94P-710/890
Material no.			
2.1462			

### Composition, typical analysis (% w/w):

Cu	P				
93.80	6.20				

### Technical specifications

Working temperature	760 °C	Tensile strength	250 N/mm <sup>2</sup>
Melting range	710 - 890 °C	Elongation	5%
Specific weight	8.1 g/cm <sup>3</sup>		

### Characteristics/application

Filler metal with good flowing properties and capillary action. For gap brazing on copper, brass, tin-bronze, and red brass. For joint brazing at working temperatures between -60 °C and +150 °C, determined using the Charpy impact test in accordance with DIN EN 10045.

Do not use in sulfuric atmospheres or on Fe and Ni alloys.

### Heat sources

Acetylene torch, conduction and resistance heating, WIG torch

### Flux

No flux needed when used on copper  
F 300 series

## Fontargen A 3002 FreeFlow

Silver containing copper-phosphorus alloy

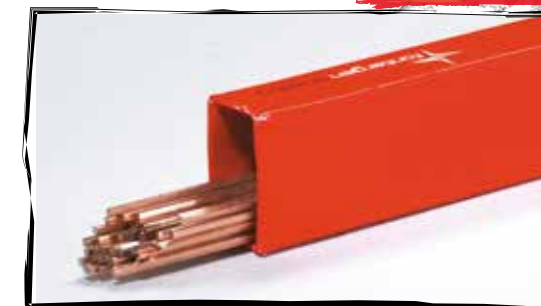

### Classifications

DIN EN ISO 17672	DIN EN 1044	DIN 8513	DIN EN ISO 3677
CuP 280	CP 105	L-Ag2P	B-Cu91PAg-643/788
AWS A5.8	Material no.		
BCuP-6			

### Composition, typical analysis (% w/w):

Cu	P	Ag			
91.00	7.00	2.00			

### Technische Angaben

Working temperature	740 °C	Tensile strength	250 N/mm <sup>2</sup>
Melting range	643 - 788 °C	Elongation	5%
Specific weight	8.1 g/cm <sup>3</sup>	Electrical conductivity	4 Sm/mm <sup>2</sup>

### Characteristics/application

A 3002 FreeFlow is a very homogeneous Copper-phosphorus alloy with low silver content. Its high flow characteristics allows the operator to produce fast reproducible joint assemblies for gap brazing on copper and copper alloys. Joint-brazing at working temperatures between -60 °C and +150 °C, determined by notched flexural impact tests according to DIN EN 10045. Do not use in sulphurous environment and on Fe- and Ni-alloys.

### Heat sources

Flame, induction and resistance heating, TIG-torch.

### Brazing fluxes

Only copper alloys require the use of flux  
F 300 series

## Fontargen A 3005 FreeFlow

Copper-phosphorus alloy containing silver



### Classifications

DIN EN ISO 17672	DIN EN 1044	DIN 8513	DIN EN ISO 3677
CuP 282			B-Cu88PAg-643/771
AWS A 5.8	Material no.		
BCuP-7			

### Composition, typical analysis (% w/w):

Cu	P	Ag			
Rest	6.50 - 6.90	5.00			

### Technical specifications

Working temperature	710 °C	Specific weight	ca. 8.2 g/cm <sup>3</sup>
Melting range	643 - 771 °C		

### Characteristics/application

Very uniform copper-phosphorous alloy containing silver. Excellent flowing properties for a fast and reproducible brazing process. High ductility. For gap brazing on copper, brass, tin-bronze, and red brass. For joint brazing at working temperatures between -60 °C and +150 °C, determined using the Charpy impact test in accordance with DIN EN 10045. Do not use in sulfuric atmospheres or on Fe and Ni alloys.

### Heat sources

Acetylene torch, conduction and resistance heating, WIG torch

### Brazing fluxes

No flux needed when used on copper  
F 300 series

## Fontargen A 3015

Copper-phosphorus alloy with high silver content

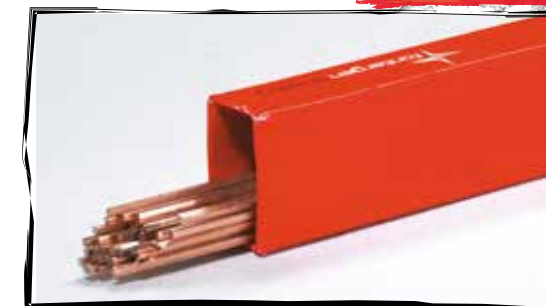

### Classifications

DIN EN ISO 17672	DIN EN 1044	DIN 8513	DIN EN ISO 3677
CuP 284	CP 102	L-Ag15P	B-Cu80AgP-645/800
AWS A5.8	Material no.		
BCuP-5	2.1210		

### Composition, typical analysis (% w/w):

Cu	P	Ag			
80.00	5.00	15.00			

### Technische Angaben

Working temperature	700 °C	Tensile strength	250 N/mm <sup>2</sup>
Melting range	645 - 800 °C	Elongation	10%
Specific weight	8.4 g/cm <sup>3</sup>	Electrical conductivity	7 Sm/mm <sup>2</sup>

### Characteristics/application

Thin fluid copper-phosphorus alloy with high silver content and high ductility, even at low temperatures. Suitable for gap brazing of copper and copper alloys. Recommended for joints with strong thermal load and vibrations. Joint-brazing at working temperatures between -70 °C and +150 °C. Do not use in sulphurous environment and on Fe- and Ni-alloys.

### Heat sources

Flame, induction and resistance heating, TIG-torch.

### Brazing fluxes

Only copper alloys require the use of flux  
F 300 - Series

# Fontargen A 407 L

Aluminum hard solder



## Classifications

DIN EN ISO 17672	DIN EN 1044	DIN 8513	DIN EN ISO 3677
Al 112	AL 104	L-AISI12	B-Al88Si-575/585
AWS A 5.8	Material no.		
BAISI-4	3.2285		

## Composition, typical analysis (% w/w):

Al	Si				
88.00	12.00				

## Technical specifications

Working temperature	590 °C	Specific weight	2.7 g/cm <sup>3</sup>
Melting range	575 - 585 °C	Tensile strength	100 N/mm <sup>2</sup>

## Characteristics/application

Good capillary action. For structure and color matching on aluminum and rolled/cast aluminum alloys. The Mg content must be ≤ 3%. The solidus temperature should be > 630 °C. Not suitable for joints that are to be anodized. This brazing alloy is also suitable for joining aluminum with Cr-Ni steel.

## Heat sources

Inert gas furnace, vacuum furnace, induction and resistance heating, acetylene torch

## Brazing fluxes

F 400 series

# Fontargen A 202 M

Copper-silicon wire electrode for  
MIG brazing



## Classifications

DIN EN ISO 24373	DIN 1733	AWS A 5.7
S Cu 6560 (CuSi3Mn1)	SG-CuSi3	ERCuSi-A
Material no.		
2.1461		

## Typical analysis of the weld metal (% w/w)

Cu	Fe	Mn	Si	Sn	Zn
Remainder	0.20	1.20	2.90	0.10	0.10

## Mechanical properties of pure welding deposit in accordance with DIN EN 1597-1 (minimum values at room temperature)

Melting range	965 - 1032 °C	Impact energy	60 J
Tensile strength	350 N/mm <sup>2</sup>	Thermal conductivity	35 W/m · K
Yield strength	120 N/mm <sup>2</sup>	Electrical conductivity (20°C)	3 - 4 Sm/mm <sup>2</sup>
Elongation (l=5d)	40%	Thermal expansion coefficient	18.1 · 10 <sup>-6</sup> /K
Hardness (Brinell)	80 HB	Specific weight	8.5 kg/dm <sup>3</sup>

## Characteristics/application

MIG brazing of zinc or aluminum-plated and uncoated steel plates. Applications: car body, air conditioning, ventilation, and container construction. The corrosion resistance of zinc-plated surfaces remains unaffected in the joining area. Very little deformation when brazing thin steel sheets.

## Heat sources

MIG/MAGM/laser brazing

## Protective gas (DIN EN 439)

I 1 (Argon)  
M 12 (Argon + 2.5% CO<sub>2</sub>)  
M 13 (Argon + 1 - 3% O<sub>2</sub>)

## Current mode

DC (positive terminal)

## Delivery form

Diameter (mm): 0.8/1.0/1.2/1.6

## Spool type

B300 (Basket coil), S200, S300 (Mandrel), Barrel coil, Additional delivery forms on request

## Approvals

TÜV

## Welding position, in accordance with DIN EN 287

PA	PB	PC	PD	PE	PF	PG
x	x	x		x	x	



# Notes

Lined area for notes, consisting of approximately 22 horizontal lines.



# Fontargen Brazing fluxes

## Brass and German-silver fluxes (in accordance with DIN EN 1045 (DIN 8511))

### F 100 (FH 21 / F-SH2)

White paste, non-corrosive, for brazing of steel, cast iron, malleable cast-iron, nickel and nickel alloys.

### F 120 (FH 21 / F-SH2)

White powder, non-corrosive, for brazing of steel, cast iron, malleable cast-iron, nickel and nickel alloys. Mixed with distilled water, the powder becomes an easy-to-spread flux paste.

### Rapidflux (FH 21 / F-SH2)

Clear liquid, non-corrosive, for brazing of steel, cast iron, malleable cast iron, nickel and nickel alloys. The liquid is used in conjunction with the appropriate Rapidflux equipment and is fed through the burner directly to the brazing joint.

### Rapidflux NT (FH 21 / F-SH2)

Clear, non-toxic liquid, non-corrosive, for brazing of steel, cast iron, malleable cast iron, nickel and nickel alloys. The liquid is used in conjunction with the appropriate Rapidflux equipment and is fed through the burner directly to the brazing joint.

## Aluminum fluxes (in accordance with DIN EN 1045 (DIN 8511))

### F 400 NH (FL 20 / F-LH2)

White powder, non-corrosive, for brazing of aluminum and aluminum alloys with a Mg content of max. 0.5%. The powder is non-hygroscopic and mixed with distilled water it becomes an easy-to-spread flux paste. The brazing joints must be protected from moisture after brazing.

### F 400 M (FL 10 / F-LH1)

White powder, corrosive, for brazing of aluminum and aluminum alloys with a Mg content of max. 3.0%. The paste is highly hygroscopic. Flux residues must be removed immediately after brazing is completed.

### F 400 MD (FL 10 / F-LH1)

White, easy-to-dose paste, corrosive, for brazing of aluminum and aluminum alloys with a Mg content of max. 3.0%. The paste is highly hygroscopic and should be kept in a tightly closed container. Flux residues must be removed immediately after brazing is completed.

## Silver fluxes (in accordance with DIN EN 1045 (DIN 8511))

### F 300 (FH 10 / F-SH1)

White powder, non-corrosive, for brazing of copper and copper alloys, nickel and nickel alloys, alloyed and unalloyed steel. Mixed with distilled water, the powder becomes an easy-to-spread flux paste.

### F 300 H Ultra (FH 10 / F-SH1)

White, easy-to-spread paste, corrosive, for brazing of copper and copper alloys, nickel and nickel alloys, alloyed and unalloyed steel.

### F 300 H Ultra NT (FH 10 / F-SH1)

White, easy-to-dose, non-toxic paste, corrosive, for brazing of copper and copper alloys, nickel and nickel alloys, alloyed and unalloyed steel. Well suited for mechanical brazing, e.g. flame brazing.

### F 300 HF Ultra (FH 12 / F-SH1)

Dark, easy-to-spread paste, corrosive, for brazing of copper and copper alloys, nickel and nickel alloys, alloyed and unalloyed steel and carbides. Particularly well suited for higher temperatures up to max. 850 °C.

### F 300 DN (FH 10 / F-SH1)

White, easy-to-dose paste, corrosive, for brazing of copper and copper alloys, nickel and nickel alloys, alloyed and unalloyed steel. Well suited for mechanical brazing, e.g. flame brazing.

### F 3400, F3400S (not standardized)

Clear sprayable liquid, slightly corrosive, for brazing of copper and copper alloys. Supports the fluidity of the solder in conjunction with Rapidflux and copper-phosphor(-silver) alloys.

Handbook with all Fontargen Brazing consumables. Download at [www.voestalpine.com/welding/services/downloads](http://www.voestalpine.com/welding/services/downloads)



Chapter 4

Fontargen Brazing

Who we are



Car body construction



Car engine construction



Heating, ventilation, air conditioning, and refrigeration (HVAC&R) applications



Toolmaking

**In-depth know-how for all types of brazing.**

Through in-depth knowledge of processing methods and application methods, Fontargen Brazing provides the best brazing solutions based on proven products with German technology. Our application engineers have unique know-how based on decades of experience gained in countless application cases.

Fontargen Brazing is an internationally sought-after partner in the following focus industries:

- » Automotive body construction – with specific solutions for qualified requirements with respect to tensile strength, surface coating, and sheet thicknesses
- » Automotive engine construction – with copper- and nickel-based solder pastes that are adapted to the respective brazing task and process parameters
- » HVAC&R – with high-quality brazing consumables
- » Toolmaking – with solders and brazing technology for the brazing of carbide and diamond tools.

**Portfolio**

- » Blank and coated silver rods and wires
- » Fluxes
- » Copper-phosphorus rods and wires
- » Copper and aluminum wires
- » Copper, tin, silver, and nickel soldering paste
- » Brazing preform parts
- » Brazing foils

„We share our more than 50 years of experience with our customers and build on it with 300 new projects each year.“

Contact:  
 Philipp Koronakis  
 Vice President Business Unit Brazing  
 Tel.: +49 6351 401 190  
 E-Mail: philipp.koronakis@voestalpine.com



## There for you around the world

### Fontargen Brazing as a voestalpine Böhler Welding product brand

#### voestalpine Böhler Welding

With over 100 years of experience, voestalpine Böhler Welding is the top global address for the daily challenges in the areas of joint welding, wear and corrosion protection as well as brazing.

Customer proximity is guaranteed by more than 40 subsidiaries in 25 countries, with the support of 2,200 employees and more than 1,000 distribution partners worldwide.

#### Member of the voestalpine Group

The voestalpine Group is a steel-based technology and capital goods group headquartered in Linz, Austria, that operates worldwide. The spectrum ranges from steel production to top quality final products. 48,500 employees, 500 group companies and sites on all continents ensure the company's success. As a member of the voestalpine Group, voestalpine Böhler Welding is part of a global network of metallurgy experts.

With over 100 years of experience, voestalpine Böhler Welding is the global top address for the daily challenges in the areas of joint welding, repair, hardfacing and cladding as well as brazing.

Customer proximity is guaranteed by more than 43 subsidiaries in 25 countries, with the support of 2,300 employees, and through more than 2,000 distribution partners worldwide.

With individual consultation by our application technicians and welding engineers, we make sure that our customers master the most demanding welding challenges.

voestalpine Böhler Welding offers three specialized and dedicated brands to cater our customers' and partners' requirements.



**Lasting Connections** – As a pioneer in innovative welding consumables, Böhler Welding offers a unique product portfolio for joint welding worldwide. More than 2000 products are adapted continuously to the current industry specifications and customer requirements, certified by well-respected institutes and thus approved for the most demanding welding applications. As a reliable partner for customers, “lasting connections” are the brand's philosophy in terms of both welding and people.



**Tailor-Made Protectivity™** – UTP Maintenance ensures an optimum combination of protection and productivity with innovative and tailor-made solutions. Everything revolves around the customer and their individual requirements. That is expressed in the central performance promise: Tailor-Made Protectivity™.



**In-Depth Know-How** – As a leading brand of soldering and brazing consumables, Fontargen Brazing offers proven solutions based on 50 years of industrial experience, tried and tested processes and methods. This In-Depth Know-How has made Fontargen Brazing an internationally preferred partner for every soldering and brazing task.



